



WE BRIDGE THE GAP  
BETWEEN TESTING AND SIMULATION  
TO ACCELERATE PRODUCT DEVELOPMENT



**The COMPACT NVH Simulator**  
Enabling a complete sound and vibration experience

# The COMPACT NVH Simulator

Enabling a complete sound and vibration experience

**PRESENTER**



**Dave Bogema**  
Director – NVH Solutions  
VI-grade

**INTRODUCTION**



Design and engineer the sound and vibration of your vehicle to meet brand and customer expectations before building the first prototype.

N V H



- Interactive NVH driving simulation on the desktop
  - Real-time Auralisation of NVH data
  - Adds Context and Interactivity to the Evaluations
  - Experience the sound for any driving condition
  - Switch between vehicles back-to-back
  - Create and drive vehicles that don't exist
  - *Targets / What If's / New Designs / ...*
  - Real-time Visualization & Modification
  - Capture the opinion and driving behavior i.e. the decision-making



THE DESKTOP NVH SIMULATOR

## Multi-sensory NVH Simulation - Sound, Vibration, Visuals

- Multi-axial, calibrated vibration at all primary driver touch points
- Calibration, synchronized sound and vibration generation

## The ultimate NVH experience

- All the same benefits of the desktop simulator, plus vibration and a fully immersive driving experience

## Sound, Vibration and Steering Multi-DOF Vibration + Sound

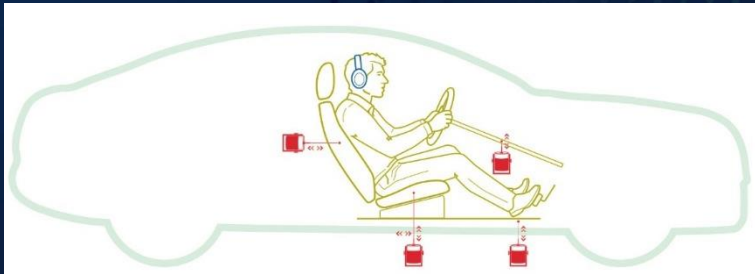

THE STATIC NVH SIMULATOR



- Multi-sensory NVH Simulation - Sound, Vibration, Visuals

- 7 Independent degrees of freedom
  - Seat vertical, lateral, fore-aft
  - Steering wheel vertical and lateral
  - Footwell / heel point vertical and lateral
- Calibrated, full-spectrum Sound

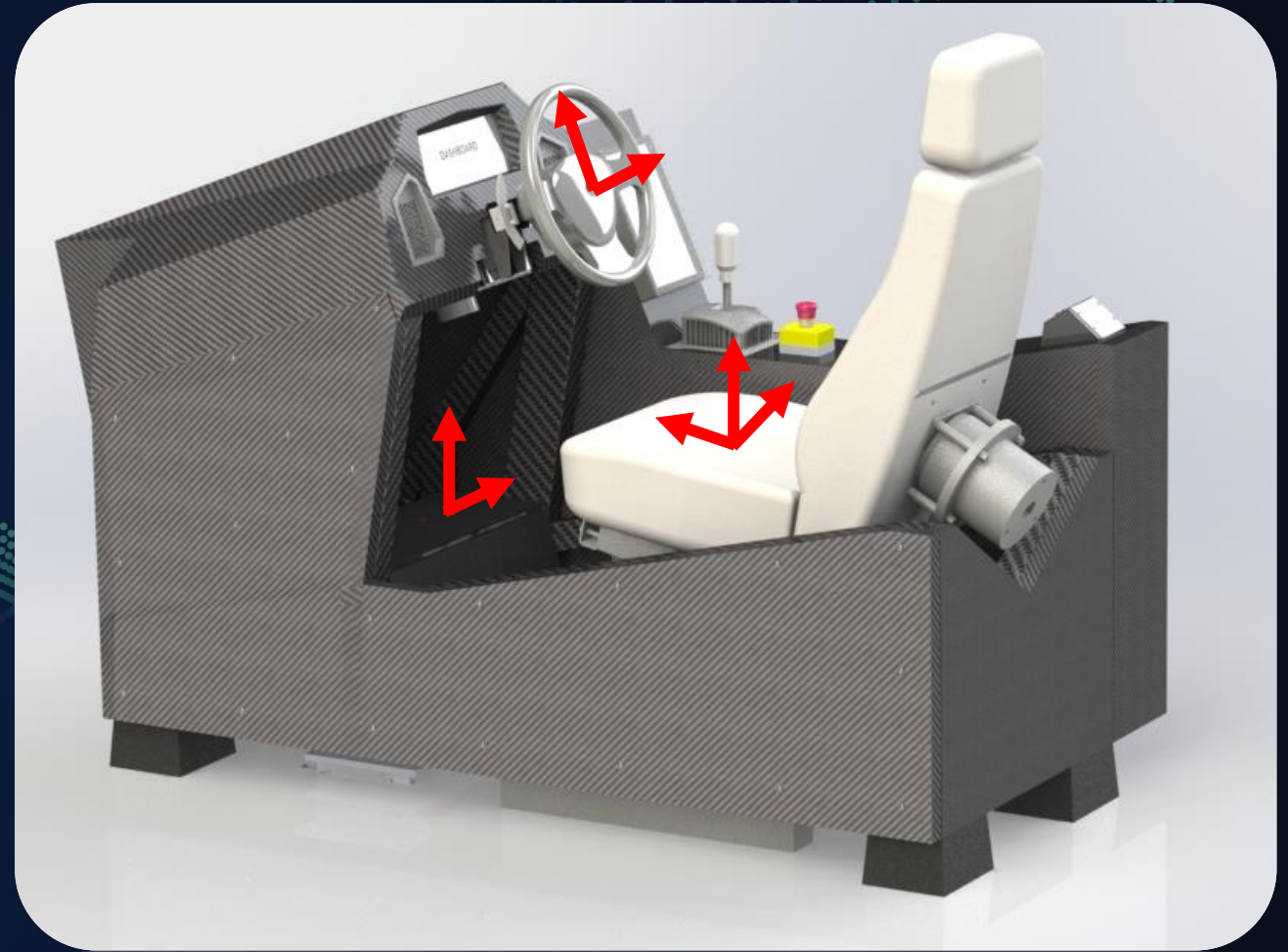

COMPACT NVH Simulator



Steering



Dash



Paddle Shifters  
Sequential / H-pattern shifter



Pedals



Touchscreen

DRIVER CONTROLS AND INTERACTION





Large Curved Screen with Projector  
Exceptional quality immersive visuals



Flat-panel Display  
High-quality visuals in a smaller space

## VISUAL DISPLAYS



CARBON FIBER CONSTRUCTION



Exterior Sound Simulator

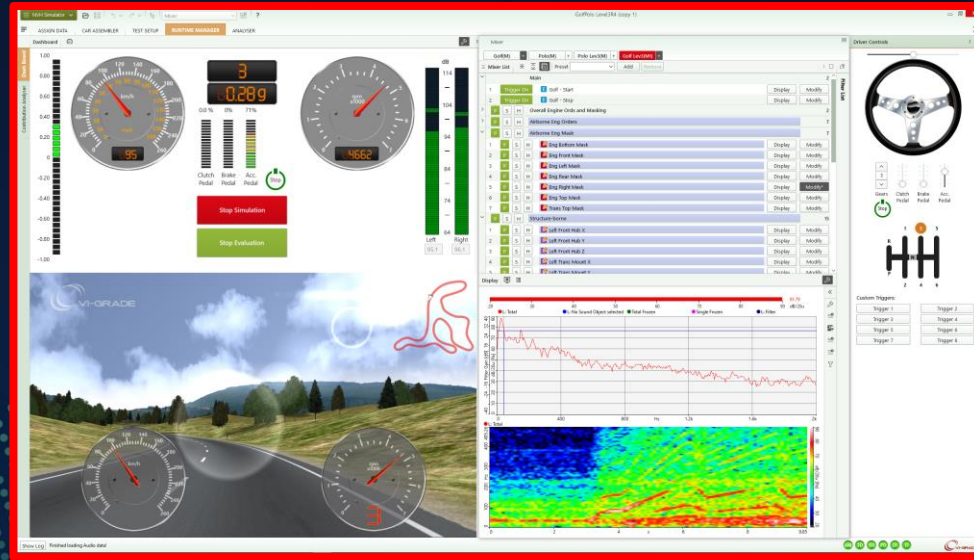

On-road Simulator



Desktop



Compact



Static

NVH SIMULATOR FAMILY

Powertrain  
- Engine  
- Motor  
- Gears and shafts

Road

Wind

Other

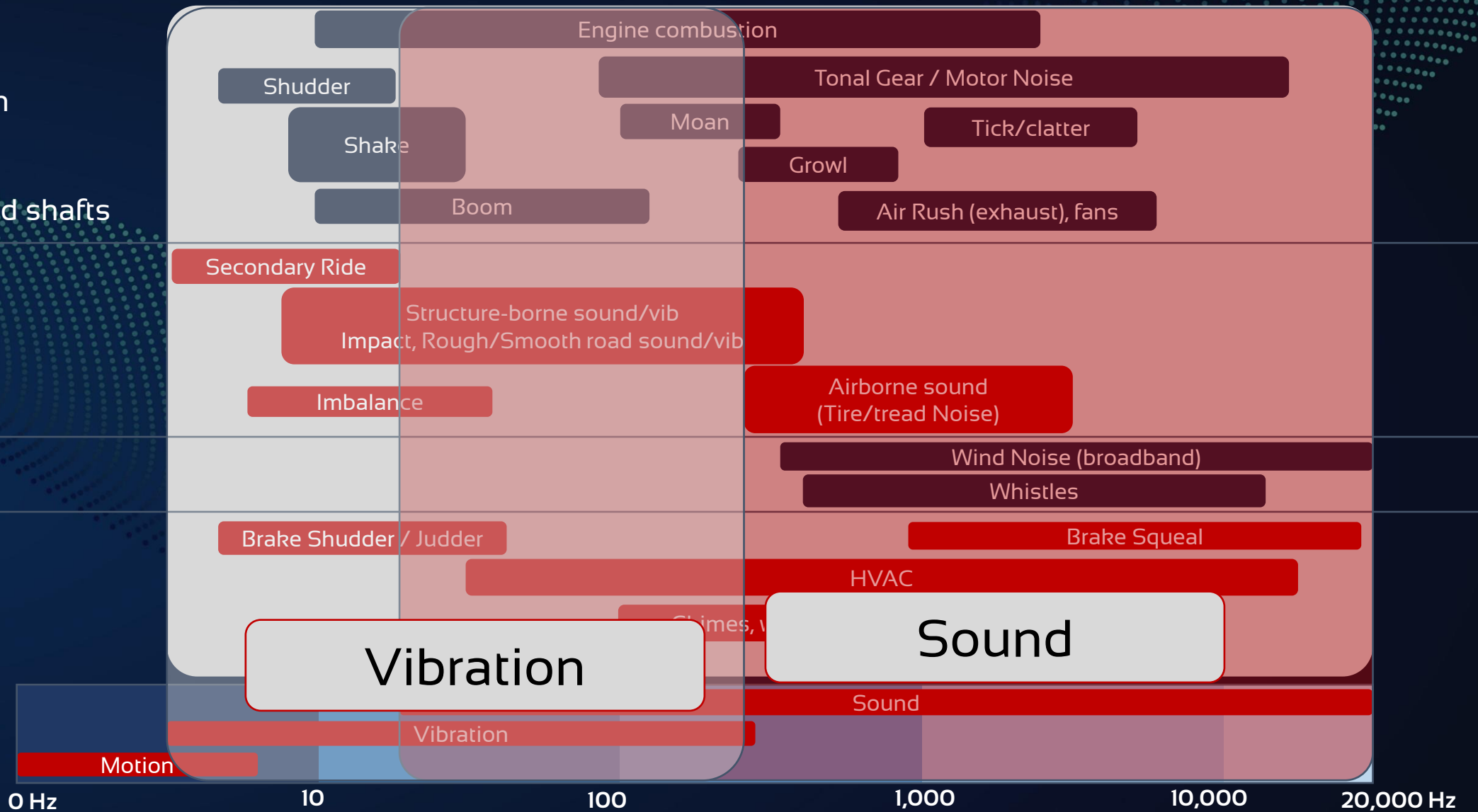

USAGE OF COMPACT NVH Simulator

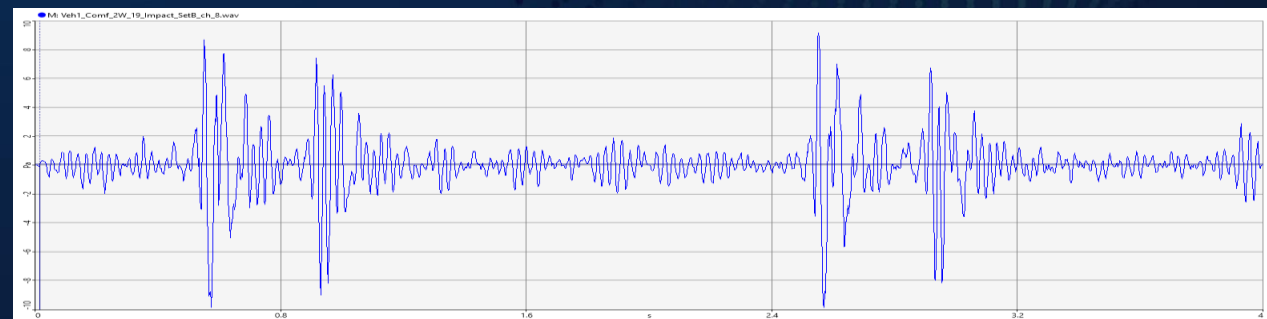

2-wheel Impacts

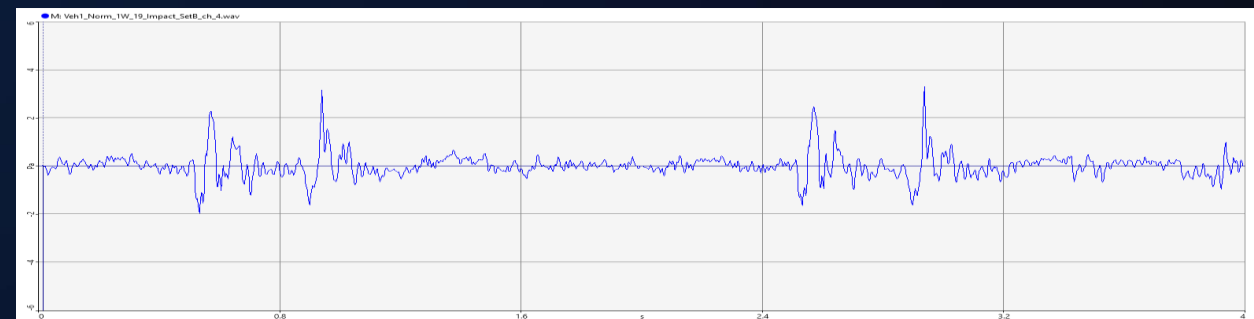

Single Side Impacts

IMPACT HARSHNESS APPLICATION



## LET'S PLAN A VISIT TO ONE OF OUR SIMCENTERS

to understand how we can help you  
streamline and accelerate your  
NVH development process

Contact:

Dave Bogema: [dave.bogema@vi-grade.com](mailto:dave.bogema@vi-grade.com)

Visit [www.vi-grade.com/NVH](http://www.vi-grade.com/NVH) for more information

Video :[Enabling a complete noise, vibration, and harshness experience with the COMPACT NVH Simulator – YouTube](#)

Launch Webinar: [WEBINAR: COMPACT NVH Simulator Introduction - YouTube](#)